

MASTER-TOUCH

ASSEMBLY GUIDE
GUÍA DE MONTAJE
GUIDE DE MONTAGE



26in/67cm



Read the owner's guide before using the barbecue.

Lisez le guide d'utilisation avant d'utiliser le barbecue.

Bitte lesen Sie das Benutzerhandbuch, bevor Sie den Grill verwenden.



8650693

04/24/23

enUS / esMX / frCA

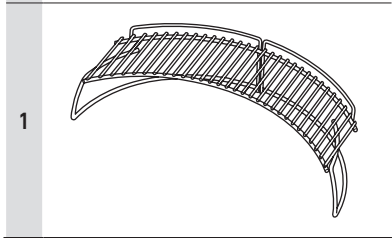
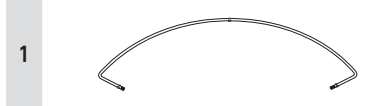
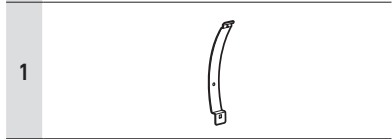
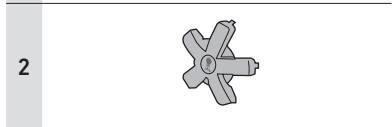
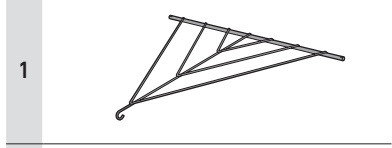
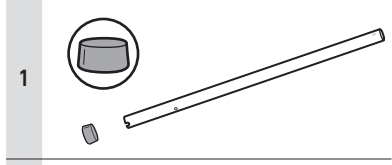
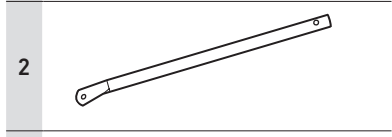
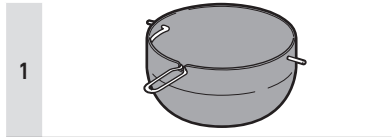
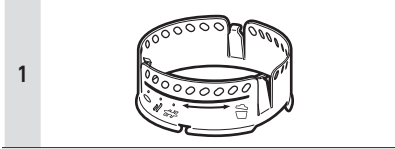
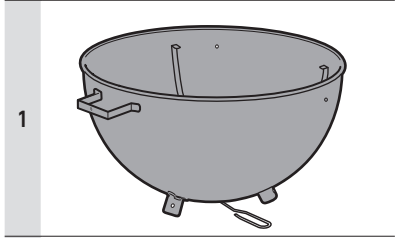
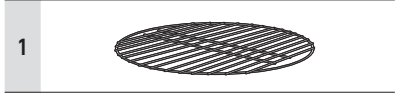
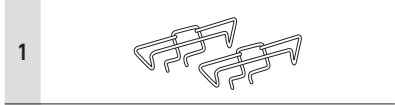
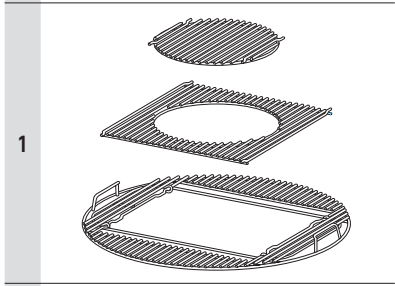
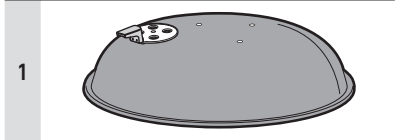

US TOOLS INCLUDED:

esMX HERRAMIENTAS INCLUIDAS:

frCA OUTILS INCLUS :



US TOOLS REQUIRED:

esMX HERRAMIENTAS NECESARIAS:

frCA OUTILS NÉCESSAIRES:

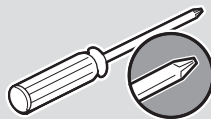

2



3

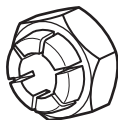

2

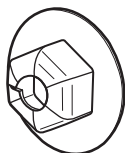

3

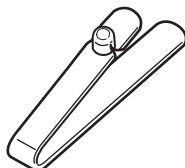

2

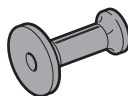

7



1

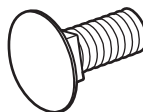

- US** ⚠ Assemble grill on a flat, level, and soft surface.
- esMX** ⚠ Arme el asador sobre una superficie llana, nivelada y lisa.
- frCA** ⚠ Assemblez le barbecue sur une surface plane souple de niveau.

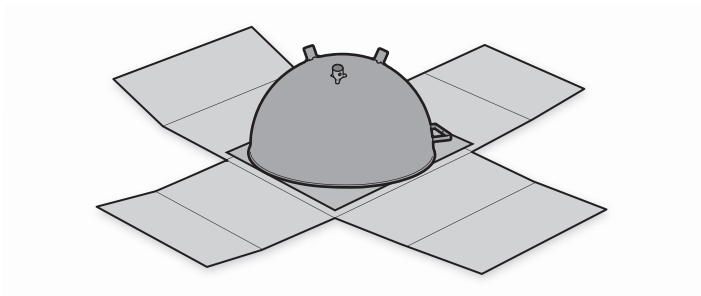

1 BILT.

- US** Download the free BILT app for 3D step-by-step instructions.
- esMX** Descargue gratis la app BILT para recibir instrucciones paso a paso en 3D.
- frCA** Téléchargez l'appli gratuite BILT qui vous expliquera le montage étape par étape en 3D.

2

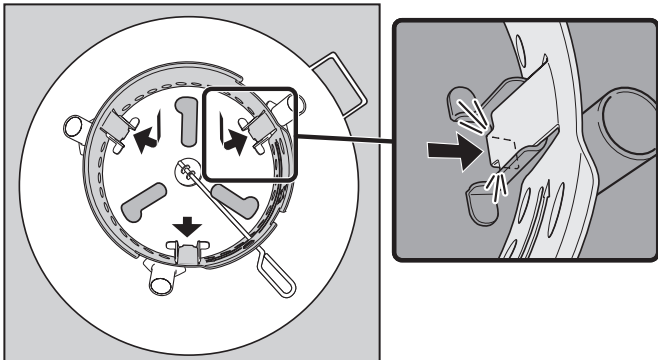
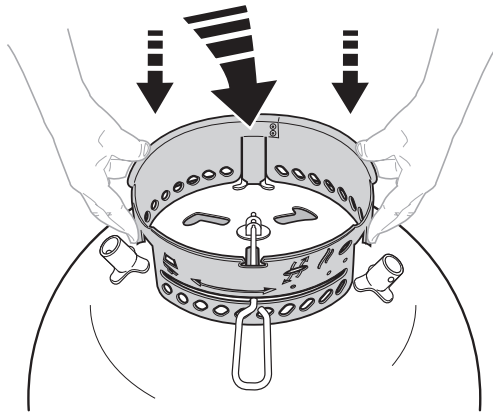
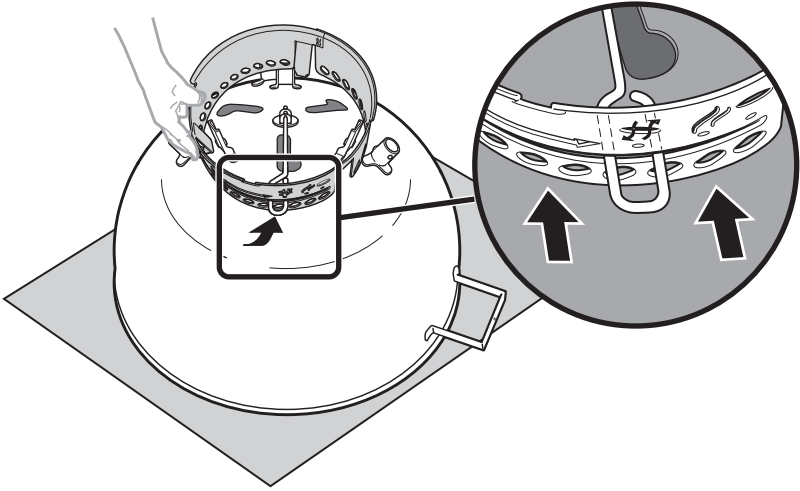

3

1-

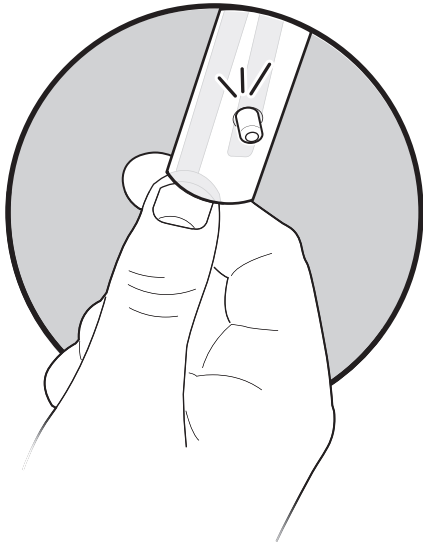
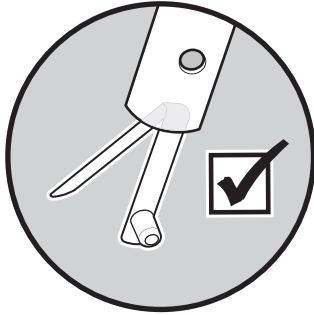
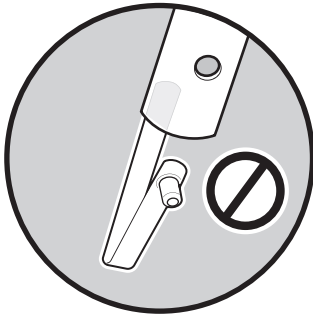
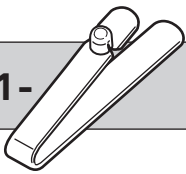

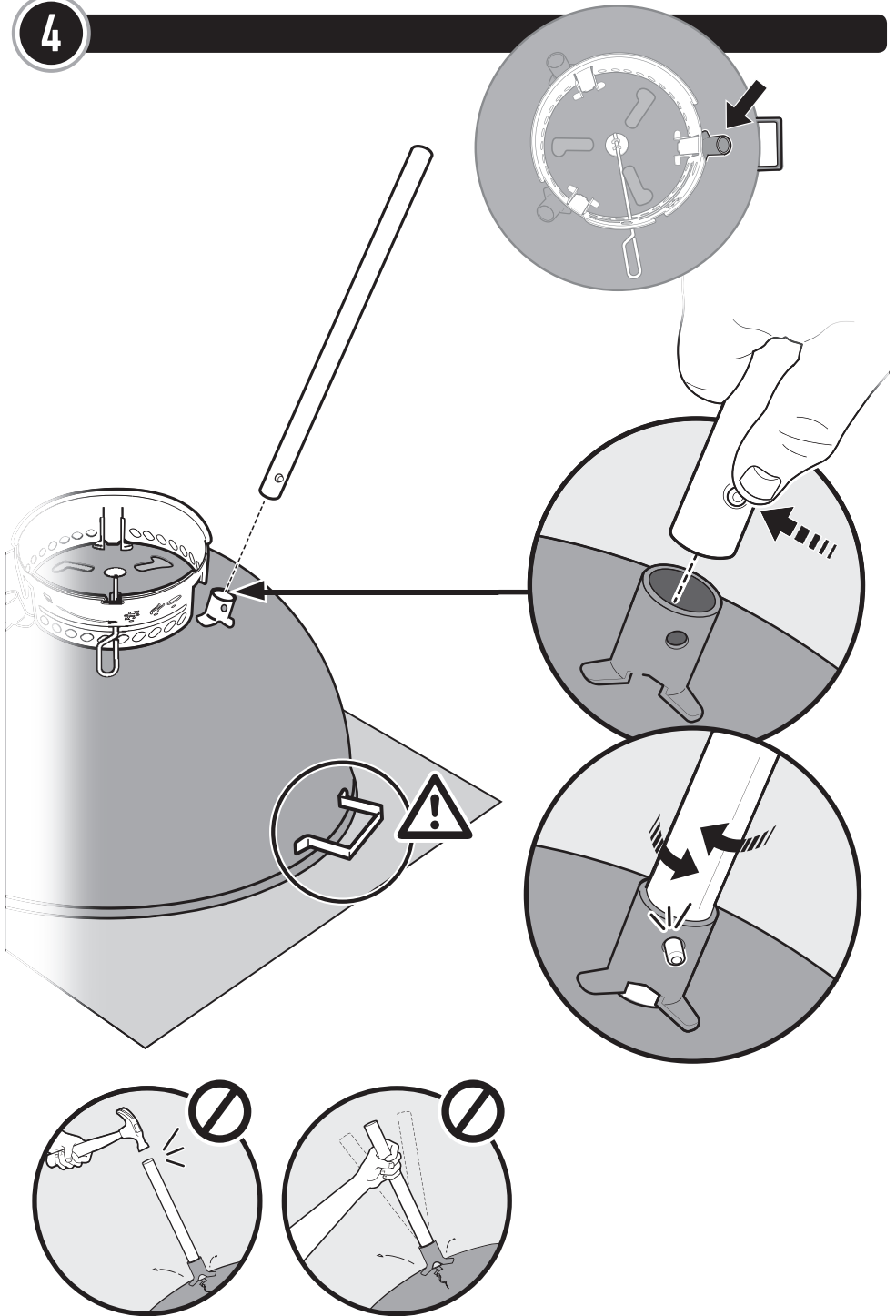

5

1-

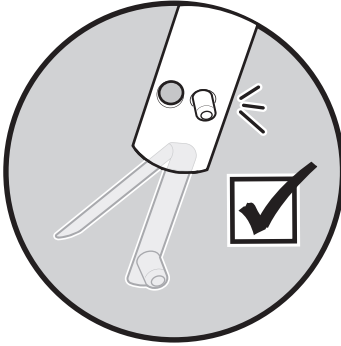
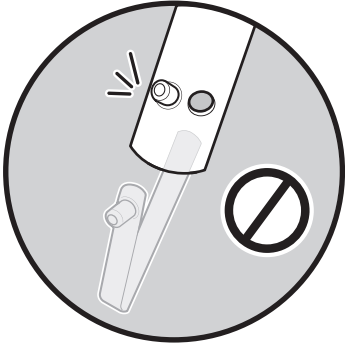
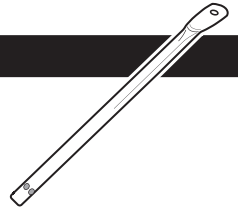
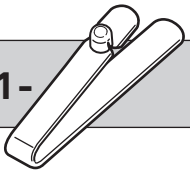

6

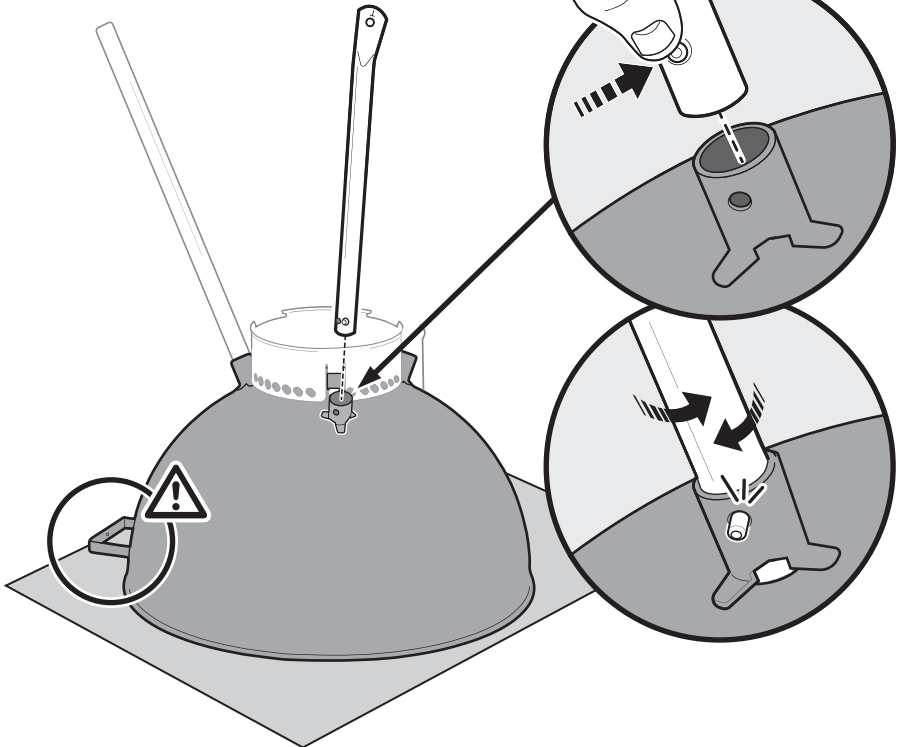

7

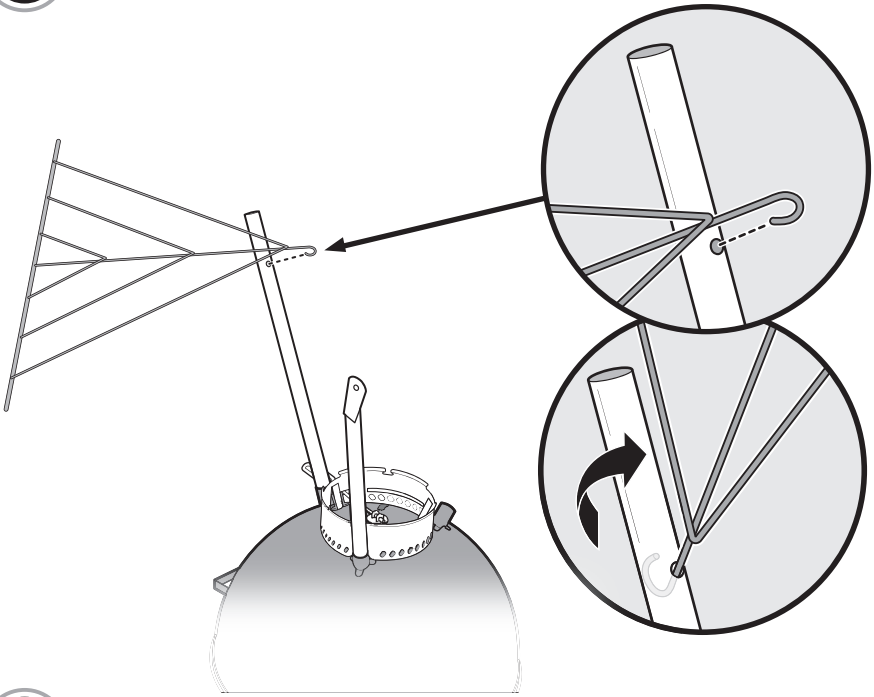

8

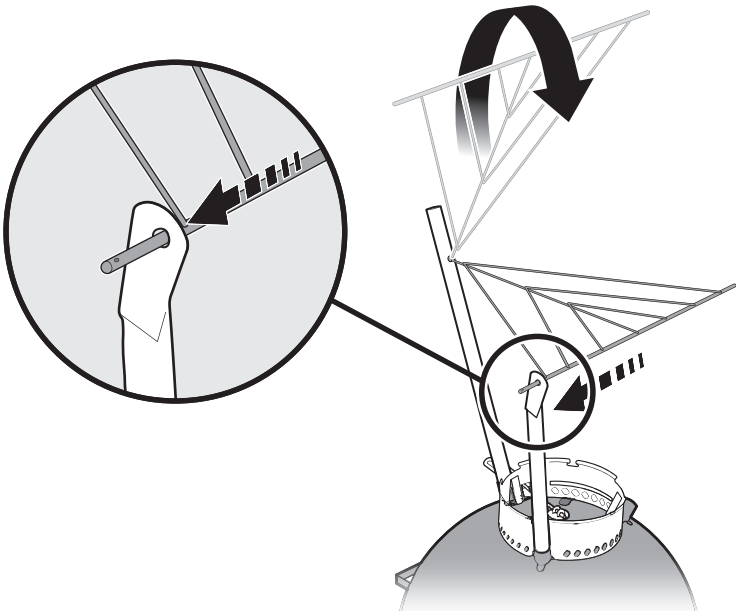

9

1-

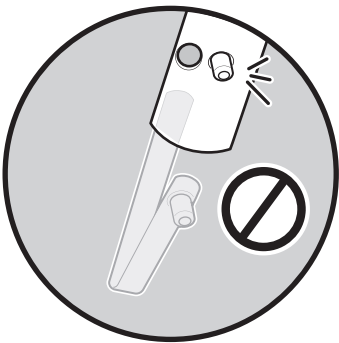
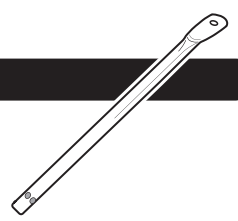
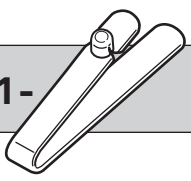

10

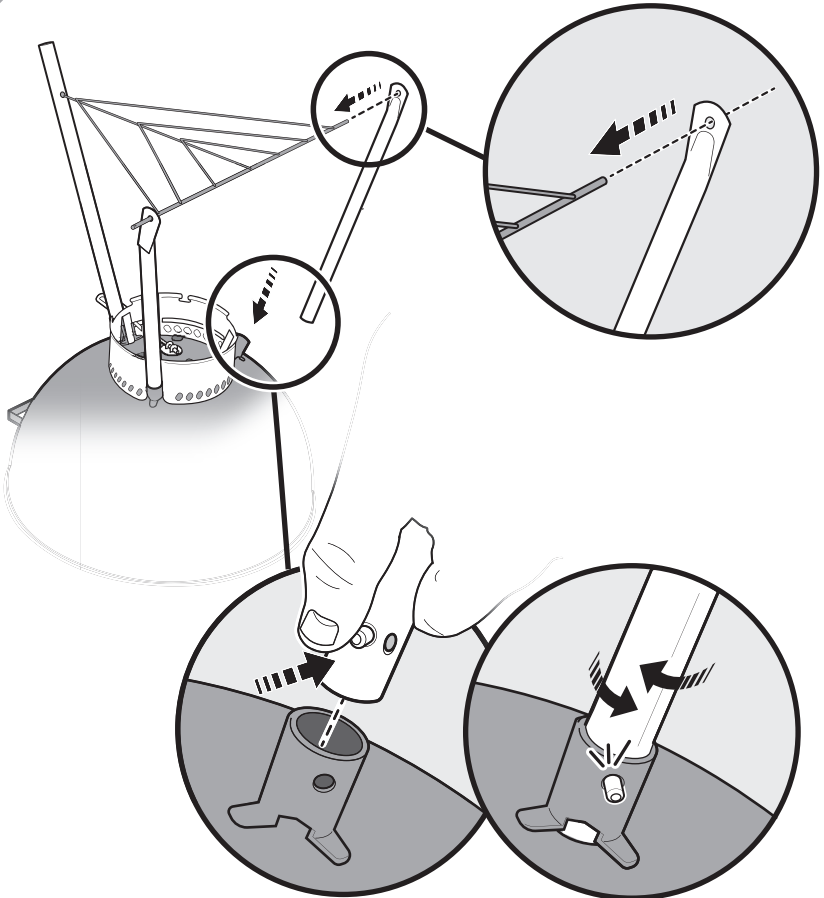

11

2-  2- 

a.

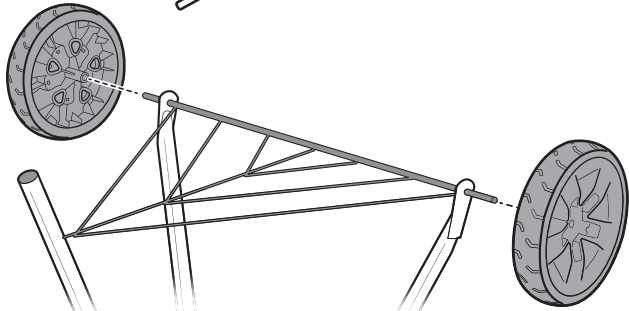

b.

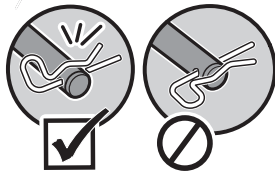
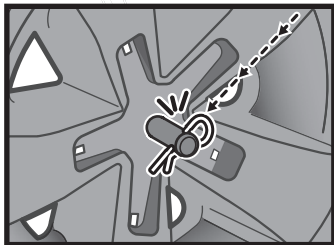

c.

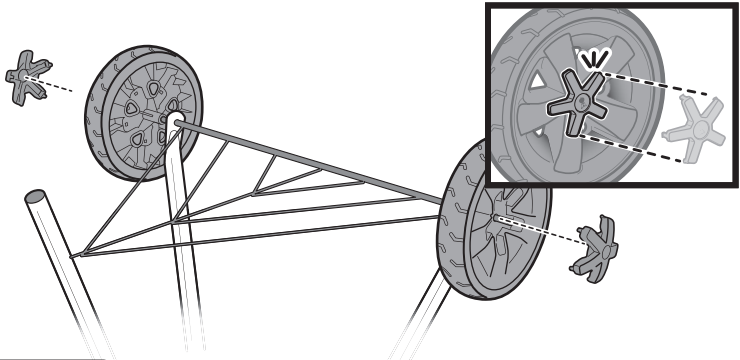

12

1- 

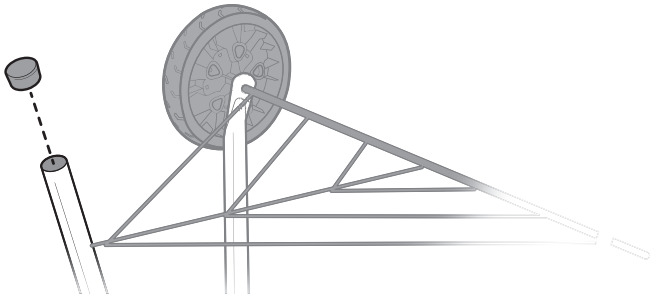

13

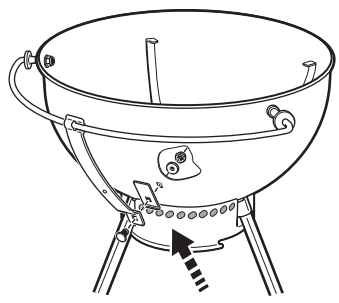
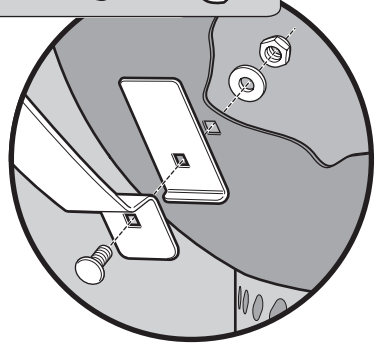
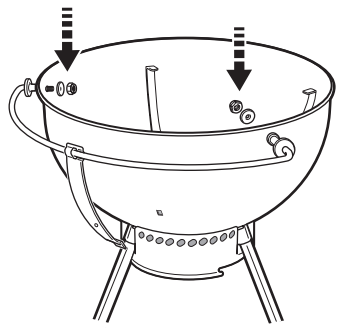
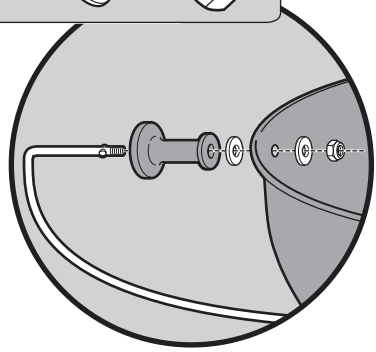
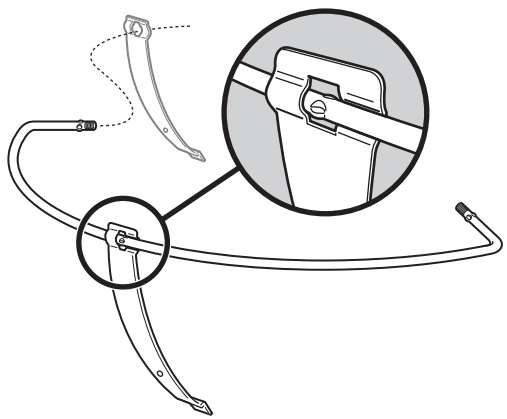

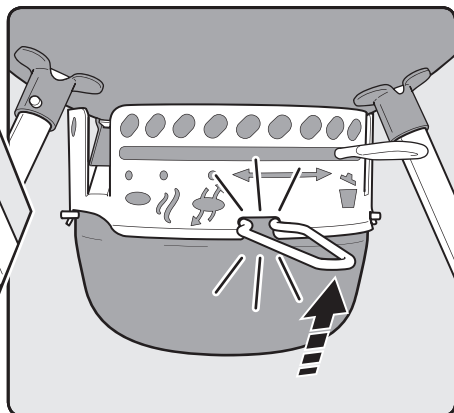
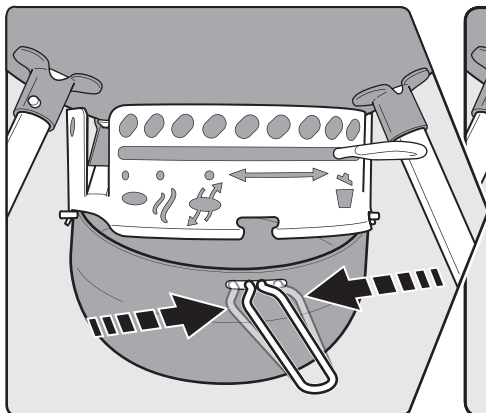
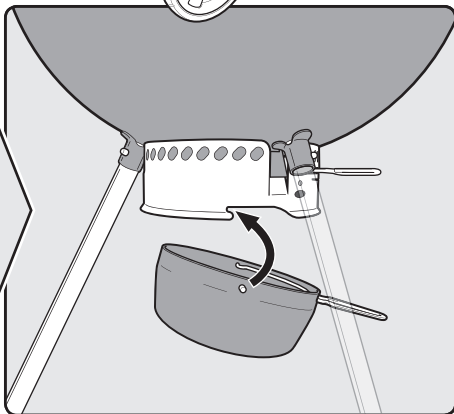
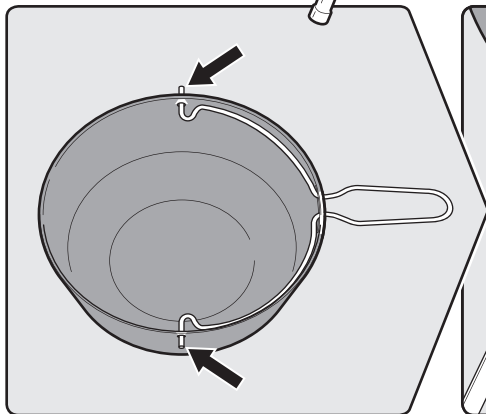
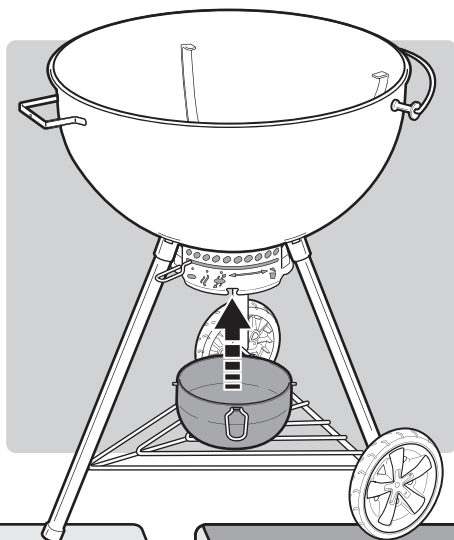

15

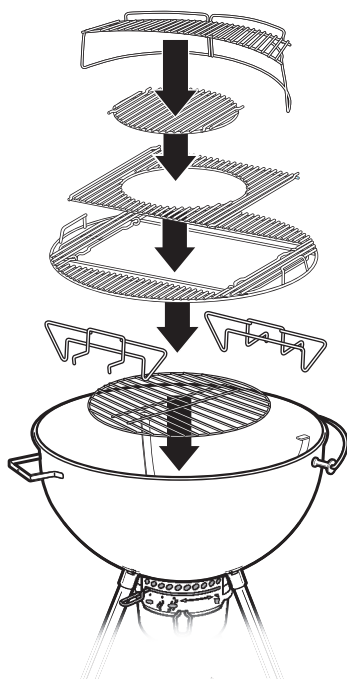

16



1-

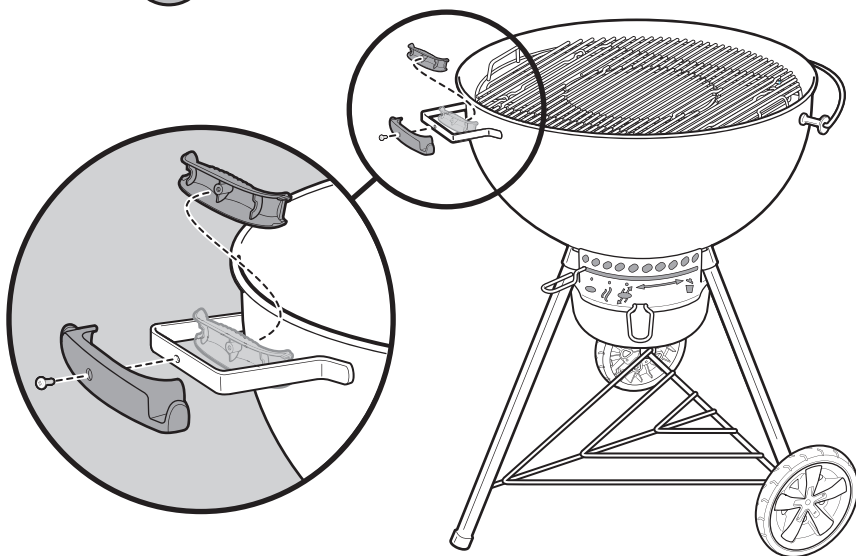

17

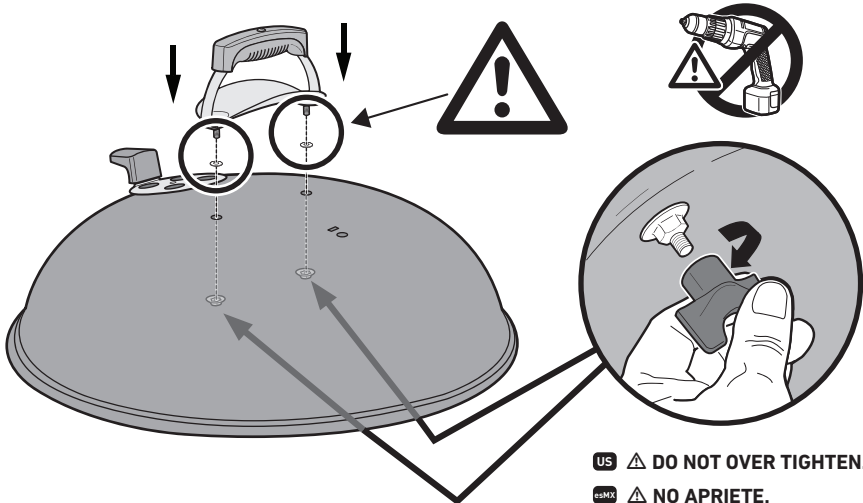
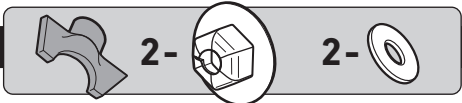

- US ⚠ DO NOT OVER TIGHTEN.
- esMX ⚠ NO APRIETE.
- frCA ⚠ NE PAS TROP SERRER.

18

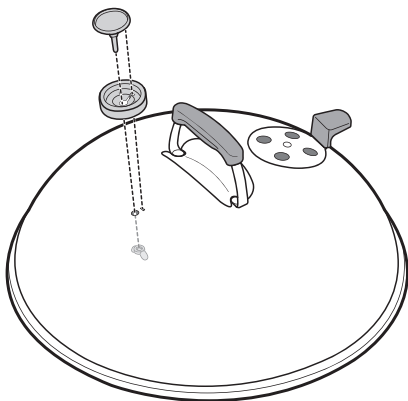
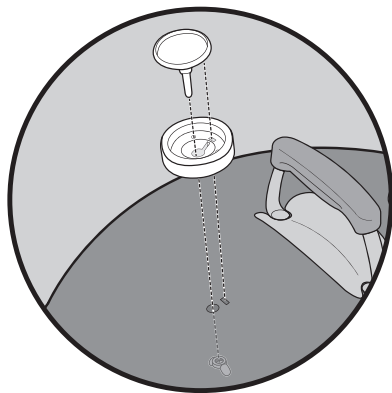

- US** Make sure that all parts are assembled and hardware is fully tightened before operating the grill.
- ES/MS** Asegúrese que todas las partes estén bien montadas y que apretó totalmente todos los herrajes antes de poner en funcionamiento el asador.
- FR/CA** Veuillez à ce que toutes les pièces soient montées et que la visserie est bien serrée avant d'utiliser le barbecue.



WEBER-STEPHEN PRODUCTS LLC
www.weber.com